

OPEN SURGERY



TC Nadelhalter

TC Needle Holders

TC Porta-agujas

TC Porte-aiguilles

TC Portaghi

051

Nadelhalter mit Hartmetalleinlagen
Needle Holders with tungsten carbide inserts

Porta-agujas con insertos de carburo tungsteno
Porte-aiguilles avec inserts en carbure de tungstène
Portaghi con morsi in carburo tungsteno

TONTARRA

TC



leichtgängige Sperre ermöglicht eine sichere Arbeitsweise.
soft working catch provides safe handling.

la cremallera suave facilita un manejo seguro.
un blocage souple permet en travailler de manière sûre.
la cremagliera leggero e preciso, permette un uso sicuro.

vergoldete Griffe als leichte Kennzeichnung.
gold-plated handles for easy identification.

mangos dorados permite una identificación fácil.
les branches plaquées d'or pour l'identification facile.
l'impugnatura dorata permette una facile identificazione.

gebrochene Kanten verhindern ein Verfangen des Nahtmaterials.
bevelled edges to prevent catching of suture material.

bordes quebrados evitan que se enreda el material de sutura.
les bords brisés empêchent que le matériel de suture s'embrouille.
i bordi squadriati evitano che si impigliano i fili di sutura.

Hartmetalleinlagen mit präzise gearbeitetem Pyramidenprofil
garantieren einen sicheren Halt der Nadel.

Tungsten carbide inserts with precisely worked out structure
guarantee to grip the needle securely.

Insertos de carburo tungsteno con perfil piramidal preciso y amolado
que garantizan una sujeción segura de la aguja.
Les inserts en carbure de tungstène avec structure pyramidale cre'es
avec précision garantissent une fixation sûre de l'aiguille.
Inserti in carburo di tungsteno garantiscono una perfetta tenuta dell'ago.

Nadelhalter mit Hartmetalleinlagen Needle Holders with tungsten carbide inserts

Porta-agujas con insertos de carburo tungsteno

Porte-aiguilles avec inserts en carbure de tungstène

Portaghi con morsi in carburo tungsteno

je nach Anwendungsgebiet stehen für TC Nadelhalter unterschiedliche Hartmetalleinlagen zur Verfügung:
according to the field of application, there are various types of tungsten carbide inserts for TC needle holders:

según campo de aplicación, disponen porta-agujas de carburo tungsteno con diferentes insertos de carburo tungsteno:

selon le domaine d'application, inserts en carbure de tungstène différents sont disponibles pour les porte-aiguilles TC:

a seconda delle necessità disponiamo dei portaghi in TC con varie placche con diverse misure della zigrinatura:

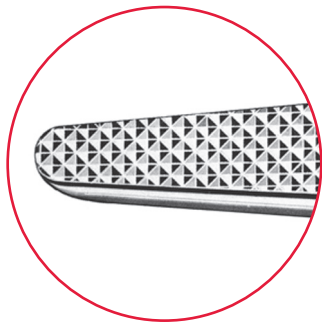



0,5 mm

**zum Halten von Nahtmaterial der Stärken 0,6 bis 3/0
for holding the suture sizes from 0,6 to 3/0**

para sujetar material de sutura de 0,6 hasta 3/0 de gruesas

pour tenir matériel de suture de 0,6 à 3/0

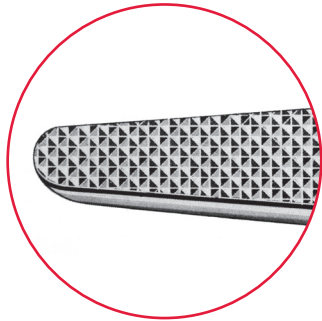
per lavorare con suture da 0,6 a 3/0



0,4 mm

**zum Halten von Nahtmaterial der Stärken 4/0 bis 6/0
for holding the suture sizes from 4/0 to 6/0**

para sujetar material de sutura de 4/0 hasta 6/0 de gruesas

pour tenir matériel de suture de 4/0 à 6/0

per lavorare con suture da 4/0 a 6/0



0,2 mm

**zum Halten von feinem Nahtmaterial der Stärken 7/0 bis 10/0
for holding the delicate suture sizes from 7/0 to 10/0**

para sujetar material de sutura fina de 7/0 hasta 10/0

pour tenir matériel de suture fin de 7/0 à 10/0

per lavorare con suture sottili da 7/0 a 10/0



**zum Halten von extrem feinem Nahtmaterial; glatt
for holding the smallest suture sizes; smooth**

para sujetar material de sutura muy fina; lisa

pour tenir matériel de suture extrêmement fin; lisse

per lavorare con suture sottilissime; piatta

Nadelhalter mit Hartmetalleinlagen
Needle Holders with tungsten carbide inserts

Porta-agujas con insertos de carburo tungsteno
 Porte-aiguilles avec inserts en carbure de tungstène
 Portaghi con morsi in carburo tungsteno

Art.Nr.	Beschreibung Description	Size	Spez.
051-010-12	DERF	12,0 cm; 4 3/4"	

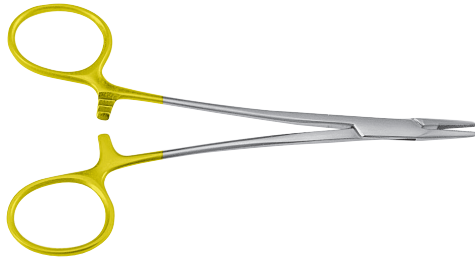

1/1

	WEBSTER	13,0 cm; 5"	
--	----------------	-------------	--



051-026-13		0,4 mm	
------------	--	--------	--

051-028-13		glatt smooth liso lisse liscio	
------------	--	--	--

051-029-13		glatt smooth liso lisse liscio	
------------	--	--	--

1/1

	HEGAR-BAUMGARTNER		
--	--------------------------	--	--

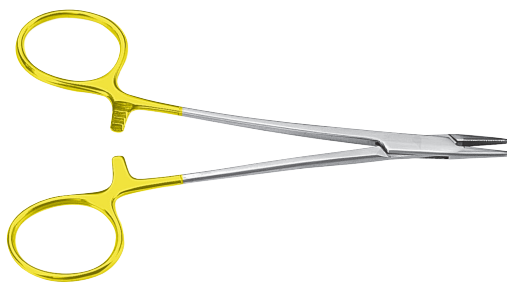

051-048-12		0,4 mm	12,5 cm; 5"
------------	--	--------	-------------

051-048-14		0,4 mm	14,0 cm; 5 1/2"
------------	--	--------	-----------------

1/1

051

Nadelhalter mit Hartmetalleinlagen
Needle Holders with tungsten carbide inserts

Porta-agujas con insertos de carburo tungsteno
 Porte-aiguilles avec inserts en carbure de tungstène
 Portaghi con morsi in carburo tungsteno

Art.Nr.	Beschreibung Description	Size	Spez.
	HALSEY	13,0 cm; 5 1/8"	

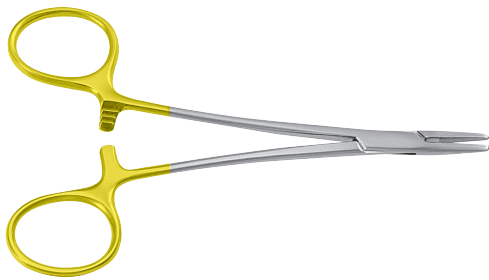

051-030-13  glatt | smooth | liso | lisse | liscio

051-040-13   0,4 mm

1/1

	HALSEY	13,0 cm; 5 1/8"
--	---------------	-----------------

für Linkshänder | for sinistral | para zurdos | pour gauchers | per mancini

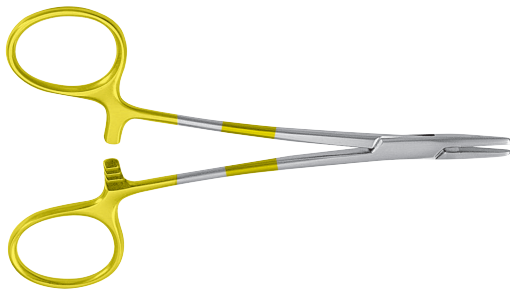

051-030-13/LH  glatt | smooth | liso | lisse | liscio

051-040-13/LH   0,4 mm

1/1

	BABY-CRILE-WOOD	15,0 cm; 6"
--	------------------------	-------------

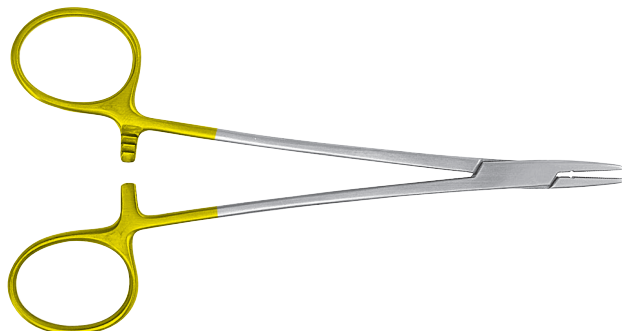

051-062-15   0,4 mm

1/1

Nadelhalter mit Hartmetalleinlagen
Needle Holders with tungsten carbide inserts

Porta-agujas con insertos de carburo tungsteno
 Porte-aiguilles avec inserts en carbure de tungstène
 Portaghi con morsi in carburo tungsteno

Art.Nr. Beschreibung | Description Size Spez.

CRILE-WOOD

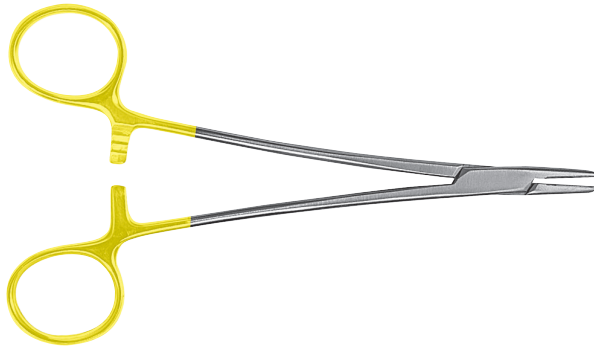

051-060-15			0,4 mm	15,0 cm; 6"
051-060-18			0,4 mm	18,0 cm; 7"
051-060-20			0,4 mm	20,0 cm; 8"
051-060-23			0,4 mm	23,0 cm; 9"
051-060-26			0,4 mm	26,0 cm; 10 1/4"
051-060-30			0,4 mm	30,0 cm; 11 3/4"

1/1

CRILE-WOOD

für Linkshänder | for sinistral | para zurdos | pour gauchers | per mancini



051-060-18/LH			0,4 mm	18,0 cm; 7"
051-060-20/LH			0,4 mm	20,0 cm; 8"
051-060-23/LH			0,4 mm	23,0 cm; 9"

1/1

051

Nadelhalter mit Hartmetalleinlagen
Needle Holders with tungsten carbide inserts

Porta-agujas con insertos de carburo tungsteno
 Porte-aiguilles avec inserts en carbure de tungstène
 Portaghi con morsi in carburo tungsteno

Art.Nr. Beschreibung | Description Size Spez.

MAYO-HEGAR

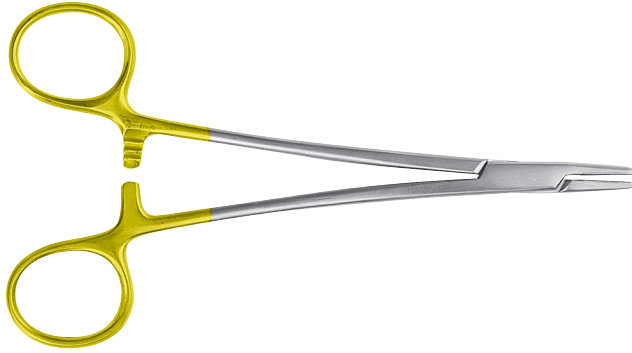

051-080-16			0,5 mm	16,0 cm; 6 1/4"
051-080-18			0,5 mm	18,0 cm; 7"
051-080-20			0,5 mm	20,0 cm; 8"
051-080-24			0,5 mm	24,0 cm; 9 1/2"
051-080-26			0,5 mm	26,0 cm; 10 1/4"
051-080-30			0,5 mm	30,0 cm; 11 3/4"

1/1

MAYO-HEGAR

für Linkshänder | for sinistral | para zurdos | pour gauchers | per mancini



051-080-18/LH			0,5 mm	18,0 cm; 7"
051-080-20/LH			0,5 mm	20,0 cm; 8"

1/1





Nadelhalter mit Hartmetalleinlagen
Needle Holders with tungsten carbide inserts

Porta-agujas con insertos de carburo tungsteno
 Porte-aiguilles avec inserts en carbure de tungstène
 Portaghi con morsi in carburo tungsteno

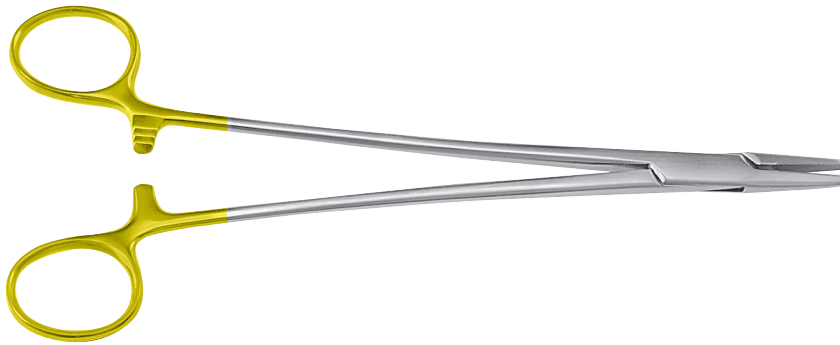
Art.Nr. Beschreibung | Description Size Spez.

HEGAR









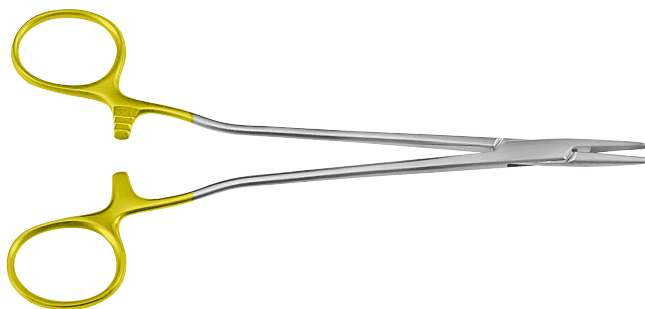

051-084-20			0,4 mm	20,0 cm; 8"
051-084-24			0,4 mm	24,0 cm; 9 2/3"

1/1

HEGAR-VASCULAR

schlankes Modell | slender pattern | modelo delgado | modèle gracile | modello gracile



051-090-14			0,4 mm	14,0 cm; 5 1/2"
051-090-18			0,4 mm	18,0 cm; 7"
051-090-20			0,4 mm	20,0 cm; 8"
051-090-23			0,4 mm	23,0 cm; 9"

1/1

051

Nadelhalter mit Hartmetalleinlagen
Needle Holders with tungsten carbide inserts

Porta-agujas con insertos de carburo tungsteno
 Porte-aiguilles avec inserts en carbure de tungstène
 Portaghi con morsi in carburo tungsteno

Art.Nr. Beschreibung | Description Size Spez.

HEGAR-VASCULAR

für Linkshänder | for sinistral | para zurdos | pour gauchers | per mancini

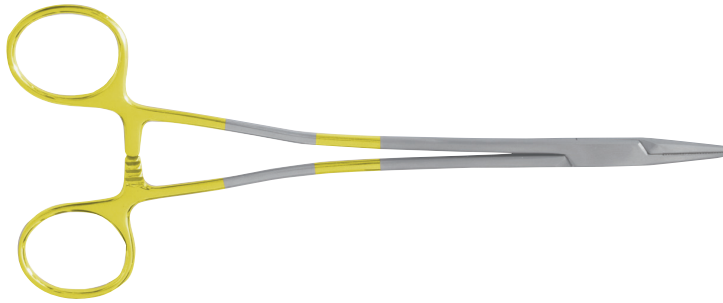

051-090-20/LH			0,4 mm	20,0 cm; 8"
051-090-23/LH			0,4 mm	23,0 cm; 9"

1/1

DE BAKEY

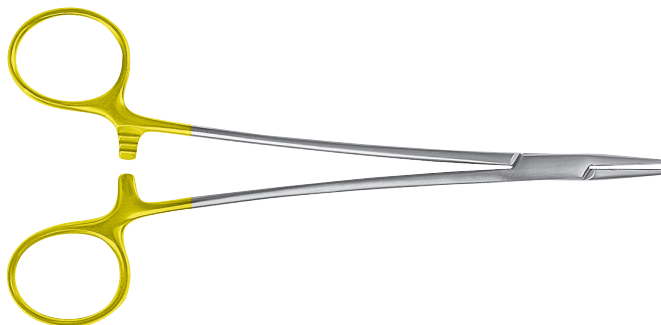

051-114-18			0,4 mm	18,0 cm; 7"
051-114-20			0,4 mm	20,0 cm; 8"
051-114-23			0,4 mm	23,0 cm; 9"
051-114-26			0,4 mm	26,0 cm; 10 1/4"
051-114-31			0,4 mm	31,0 cm; 12 1/4"
051-114-37			0,4 mm	37,0 cm; 14 1/2"

1/1

051

Nadelhalter mit Hartmetalleinlagen
Needle Holders with tungsten carbide inserts

Porta-agujas con insertos de carburo tungsteno
 Porte-aiguilles avec inserts en carbure de tungstène
 Portaghi con morsi in carburo tungsteno

Art.Nr. **Beschreibung | Description** **Size** **Spez.**

MARTINI

schlankes Modell | slender pattern | modelo delgado | modèle gracile | modello gracile

glatt | smooth | liso | lisse | liscio

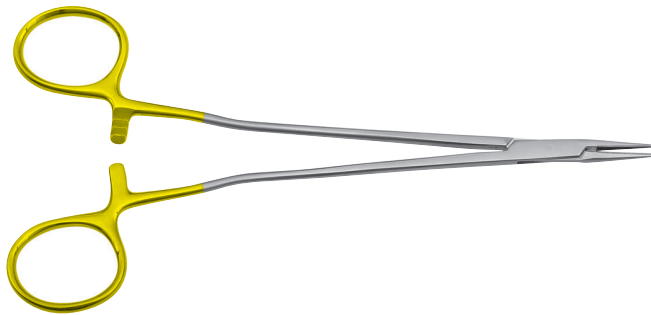

051-120-14  14,0 cm; 5 1/2"

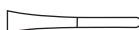
051-120-18  17,5 cm; 7"

051-120-20  20,0 cm; 8"

1/1

MICROVASCULAR

schlankes Modell | slender pattern | modelo delgado | modèle gracile | modello gracile

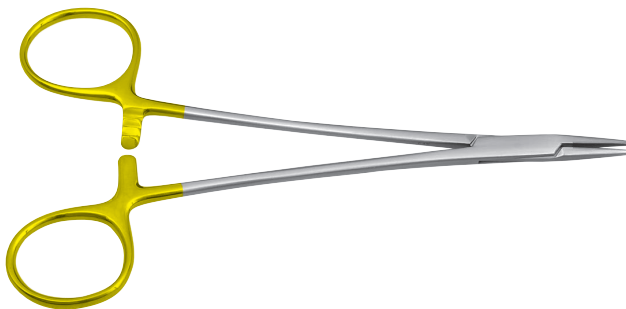

051-122-14   0,2 mm 14,0 cm; 5 1/2"

051-122-18   0,2 mm 17,5 cm; 7"

051-122-20   0,2 mm 20,0 cm; 8"

051-122-23   0,2 mm 23,0 cm; 9"

1/1

051

Nadelhalter mit Hartmetalleinlagen
Needle Holders with tungsten carbide inserts

Porta-agujas con insertos de carburo tungsteno
 Porte-aiguilles avec inserts en carbure de tungstène
 Portaghi con morsi in carburo tungsteno

Art.Nr. Beschreibung | Description Size Spez.

SAROT

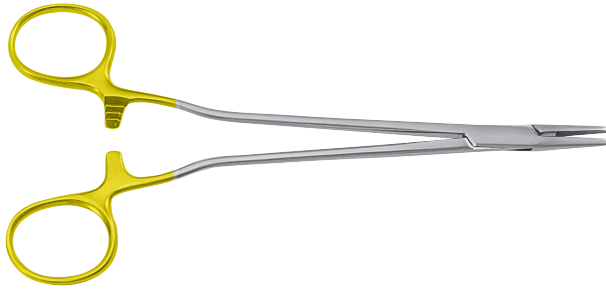

051-224-18			0,5 mm	18,0 cm; 7"
051-224-20			0,5 mm	20,0 cm; 8"
051-224-26			0,5 mm	26,0 cm; 10 1/4"

1/1

RYDER-VASCULAR

schlankes Modell | slender pattern | modelo delgado | modèle gracile | modello gracile

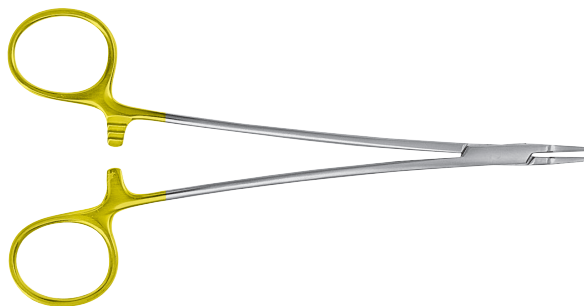

051-132-13			0,2 mm	13,0 cm; 5 1/8"
051-132-15			0,2 mm	15,0 cm; 6"
051-132-18			0,2 mm	18,0 cm; 7"
051-132-20			0,2 mm	20,0 cm; 8"
051-132-23			0,2 mm	23,0 cm; 9"
051-132-26			0,2 mm	26,0 cm; 10 1/4"

1/1

051

Nadelhalter mit Hartmetalleinlagen
Needle Holders with tungsten carbide inserts

Porta-agujas con insertos de carburo tungsteno
 Porte-aiguilles avec inserts en carbure de tungstène
 Portaghi con morsi in carburo tungsteno

Art.Nr. Beschreibung | Description Size Spez.

RYDER

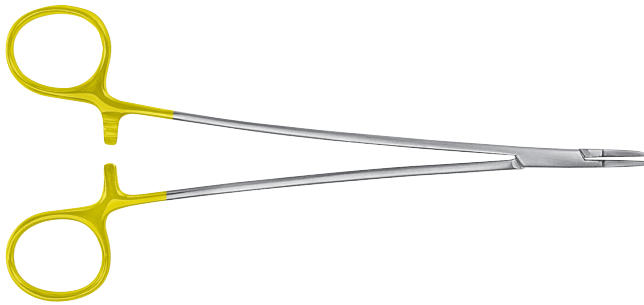

051-134-13			0,4 mm	13,0 cm; 5 1/8"
051-134-15			0,4 mm	15,0 cm; 6"
051-134-18			0,4 mm	18,0 cm; 7"
051-134-20			0,4 mm	20,0 cm; 8"
051-134-23			0,4 mm	23,0 cm; 9"
051-134-26			0,4 mm	26,0 cm; 10 1/8"

1/1

SCHWEDISCHES MODELL

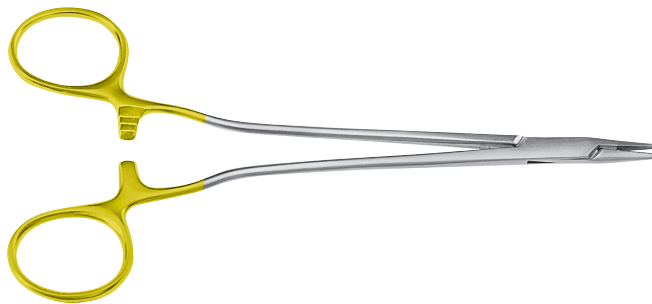

051-136-15			0,4 mm	15,0 cm; 6"
051-136-17			0,4 mm	17,0 cm; 6 3/4"
051-136-20			0,4 mm	20,0 cm; 7"

1/1

051



Nadelhalter mit Hartmetalleinlagen
Needle Holders with tungsten carbide inserts

Porta-agujas con insertos de carburo tungsteno
 Porte-aiguilles avec inserts en carbure de tungstène
 Portaghi con morsi in carburo tungsteno

Art.Nr. Beschreibung | Description Size Spez.

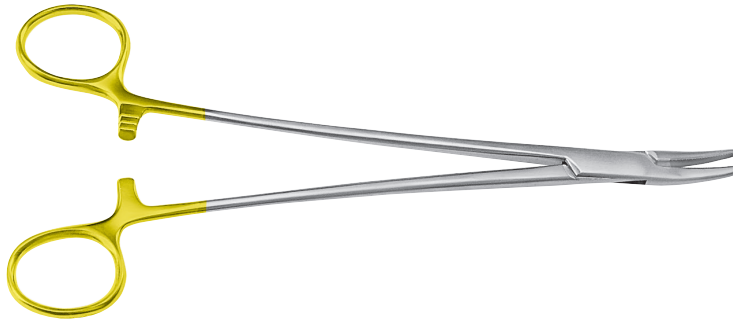
HEANEY

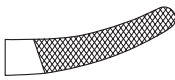





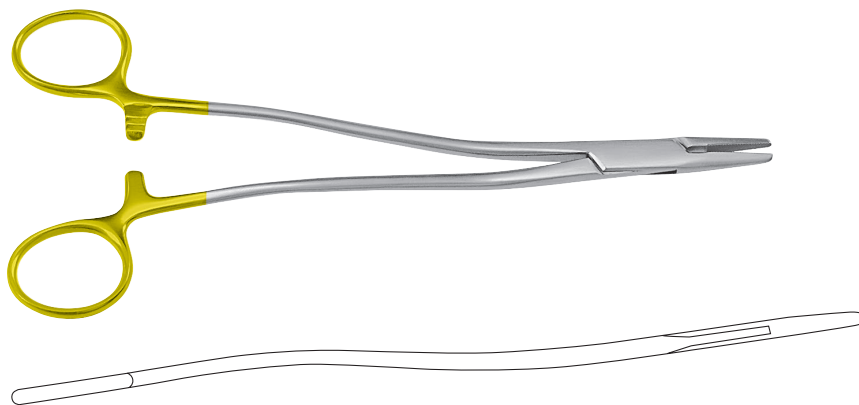

051-141-20			0,5 mm	20,0 cm; 8"
051-141-24			0,5 mm	24,0 cm; 9 1/2"
051-141-26			0,5 mm	26,0 cm; 10 1/4"

1/1

BOZEMANN (WERTHEIM)











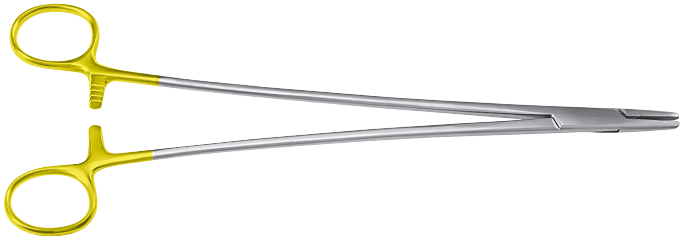

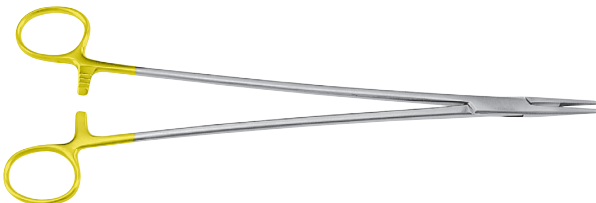

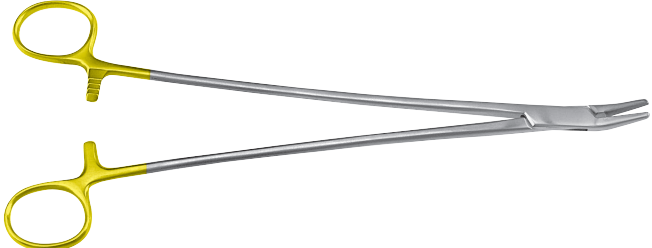
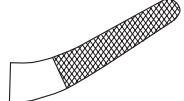
051-185-20			0,5 mm	20,0 cm; 8"
051-185-24			0,5 mm	24,0 cm; 9 2/3"
051-185-26			0,5 mm	26,0 cm; 10 1/4"

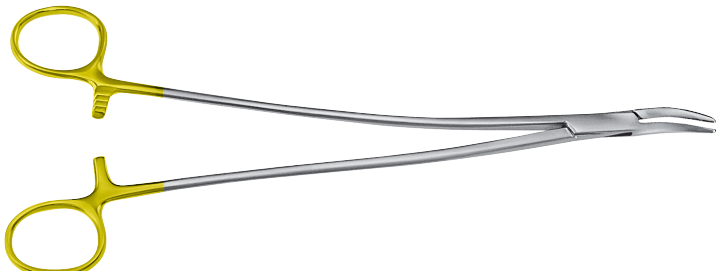
1/1

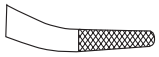
Nadelhalter mit Hartmetalleinlagen
Needle Holders with tungsten carbide inserts

Porta-agujas con insertos de carburo tungsteno
 Porte-aiguilles avec inserts en carbure de tungstène
 Portaghi con morsi in carburo tungsteno

Art.Nr.	Beschreibung Description	Size	Spez.
051-150-27	MASSON 	27,0 cm; 10 3/4"	  0,5 mm
1/1			
051-160-27	WANGENSTEEN 	27,0 cm; 10 3/4"	  0,5 mm
1/1			
051-211-27	FINOCCHIETTO 	27,0 cm; 10 3/4"	  0,5 mm
1/1			
	STRATTE 		
051-230-22	  0,5 mm	20,0 cm; 8"	
051-230-23	  0,5 mm	23,0 cm; 9"	

1/1

051

Nadelhalter mit Hartmetalleinlagen
Needle Holders with tungsten carbide inserts

Porta-agujas con insertos de carburo tungsteno
 Porte-aiguilles avec inserts en carbure de tungstène
 Portaghi con morsi in carburo tungsteno

Art.Nr. **Beschreibung | Description** **Size** **Spez.**

BARRY STERNAL

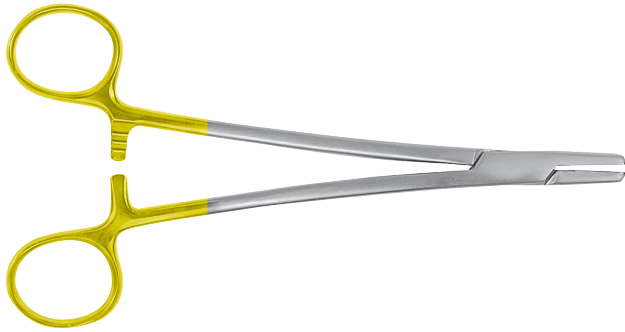

051-240-15   0,5 mm 15,0 cm; 6"

051-242-18   0,5 mm 18,5 cm; 7 1/4"

1/1

051-244-15 **MAYO-HAUBERISSER** 15,0 cm; 6"

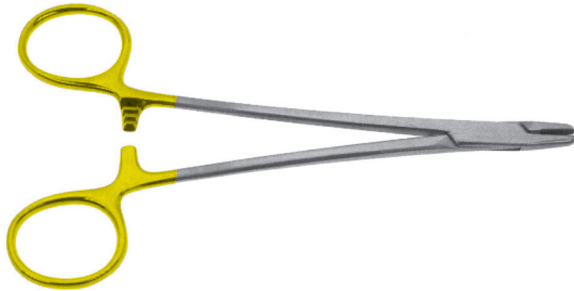

  0,5 mm

1/1

051-236-01 **CORWIN** 16,0 cm; 6 1/4"



  0,5 mm

Nadelhalter mit Hartmetalleinlagen
Needle Holders with tungsten carbide inserts

Porta-agujas con insertos de carburo tungsteno
 Porte-aiguilles avec inserts en carbure de tungstène
 Portaghi con morsi in carburo tungsteno

Art.Nr. **Beschreibung | Description** **Size** **Spez.**

OLSEN-HEGAR

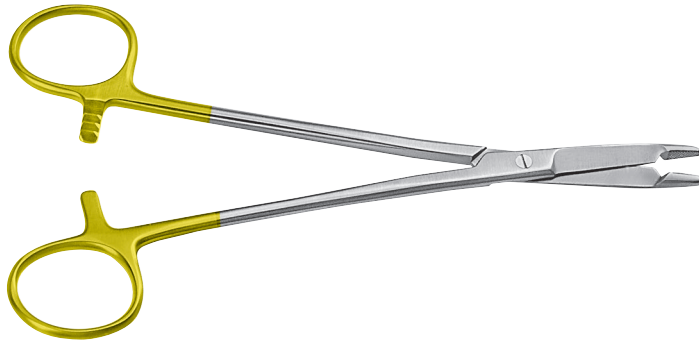

051-310-14   0,5 mm 14,0 cm; 5 1/2"

051-310-17   0,5 mm 17,0 cm; 6 3/4"

051-310-19   0,5 mm 19,0 cm; 7 1/2"

1/1

051-330-16 **GILLIES** 16,0 cm; 6 1/4"

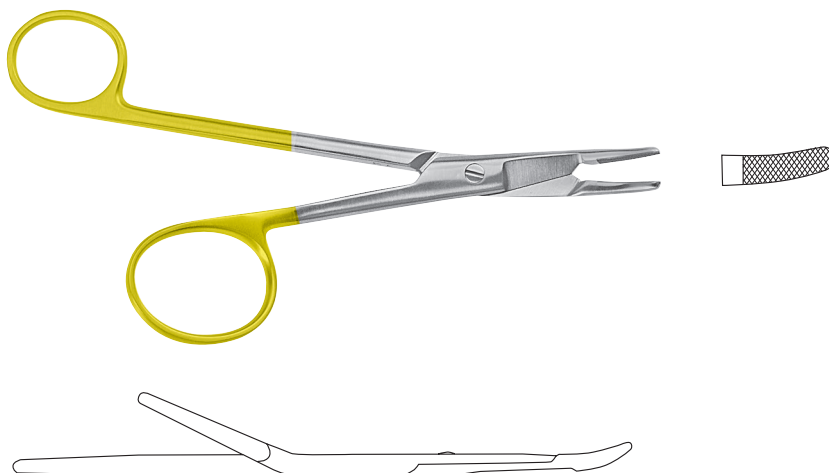







 0,5 mm

1/1

051





Nadelhalter mit Hartmetalleinlagen
Needle Holders with tungsten carbide inserts

Porta-agujas con insertos de carburo tungsteno
 Porte-aiguilles avec inserts en carbure de tungstène
 Portaghi con morsi in carburo tungsteno

Art.Nr.	Beschreibung Description	Size	Spez.
MATHIEU			
			
051-350-14	 	0,5 mm	14,0 cm; 5 1/2"
051-350-17	 	0,5 mm	17,0 cm; 6 3/4"
051-350-20	 	0,5 mm	20,0 cm; 8"







1/1

MATHIEU-METZENBAUM

			
051-351-17	 	0,5 mm	17,0 cm; 6 3/4"
051-351-20	 	0,5 mm	20,0 cm; 8"

1/1

MATHIEU-RYDER

			
051-352-17	 	0,5 mm	17,0 cm; 6 3/4"
051-352-20	 	0,5 mm	20,0 cm; 8"
051-352-24	 	0,5 mm	24,0 cm; 9 1/2"

1/1

Nadelhalter mit Hartmetalleinlagen
Needle Holders with tungsten carbide inserts

Porta-agujas con insertos de carburo tungsteno
 Porte-aiguilles avec inserts en carbure de tungstène
 Portaghi con morsi in carburo tungsteno





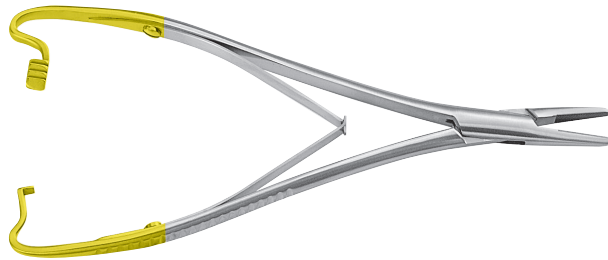

Art.Nr. Beschreibung | Description Size Spez.

MATHIEU

mit Innensperre | with interior catch

con cremallera interior avec | crémaillère intérieure | con cremagliera interna









051-356-17			0,5 mm	17,0 cm; 6 3/4"
051-356-20			0,5 mm	20,0 cm; 8"
051-356-23			0,5 mm	23,0 cm; 9"

1/1

MATHIEU-KOCHER



051-358-14			0,5 mm	14,0 cm; 5 1/2"
051-358-17			0,5 mm	17,0 cm; 6 3/4"
051-358-20			0,5 mm	20,0 cm; 8"

1/1

051

Nadelhalter mit Hartmetalleinlagen
Needle Holders with tungsten carbide inserts

Porta-agujas con insertos de carburo tungsteno
 Porte-aiguilles avec inserts en carbure de tungstène
 Portaghi con morsi in carburo tungsteno

Art.Nr. Beschreibung | Description Size Spez.

LANGENBECK



051-360-18			0,5 mm	18,0 cm; 7"
051-360-20			0,5 mm	20,0 cm; 8"
051-360-23			0,5 mm	23,0 cm; 9"

1/1

ZWEIFEL

Klappsperr | Hinged catch | Cremallera abatible | Crémaillère repliable | Cremagliera a scatto

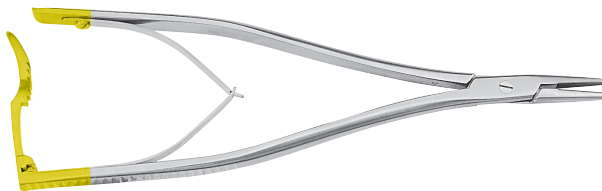

051-364-20			0,5 mm	20,0 cm; 8"
051-364-23			0,5 mm	23,0 cm; 9"

1/1

LICHTENBERG



051-366-17			0,5 mm	17,0 cm; 6 3/4"
051-366-20			0,5 mm	20,0 cm; 8"

1/1

051

